

Data Sheet



Article number: 071101450385040

Description: Cardan drive shaft 0.110.145.002
S=385 X=40 Bore with keyway

Measures

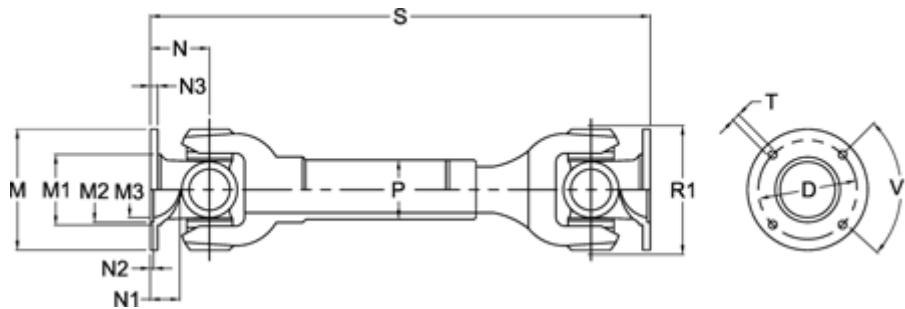

D	= 84 +-0,1	N1	= 20	T	= 8 B12
Extension X	= 40	N2	= 2,5 +0,5	V1 degrees	= 60
Flange diameter M	= 100	N3	= 7		
M1	= 66	Number og Flangeholes	= 6		
M2	= 57	P	= 50x3		
M3	= 52	R1	= 98		
Max. Bending Angle degrees	= 35	S min	= 385		
N	= 46	Spline dim. DIN 5480	= 35x2x16		